

ARTÙ

by Andrea Lucatello



Artù è un tavolo dalle forme sobrie e dalle linee minimali, funzionale nell'uso grazie ad un razionale sistema allungabile. Le gambe sono realizzate in legno massello, il piano in essenza impiallacciata su alluminio, in vetro extrachiario satinato retro laccato, in ceramica o in Fenix.

Artù is a table with sober shapes and minimal lines, functional thanks to a rational extendable system. The legs are made of solid wood, the top in veneer on aluminium, in lacquered satin extra-clear glass, in ceramic or in Fenix.

DIMENSIONI | DIMENSIONS



lunghezza | width: 150 cm
larghezza | depth: 101,3 cm
altezza | height: 77 cm

lunghezza | width: 180 cm
larghezza | depth: 101,3 cm
altezza | height: 77 cm

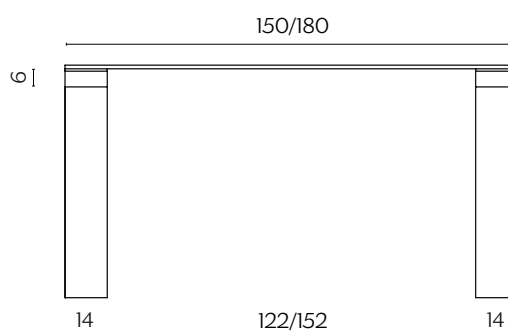
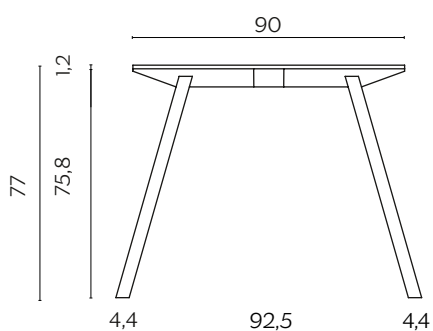

FINITURE PIANO | TOP FINISHES

LEGNO | WOOD



Rovere Fiammato
Flamed Oak



Rovere Vintage
Vintage Oak



Noce Canaletto
Canaletto Walnut



Rovere Termotrattato
Heat-Treated Oak



Frassino Nero
Black Ash

GRES PORCELLANATO | PORCELAIN STONEWARE

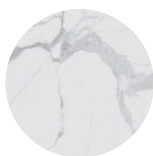

Statuario Bianco

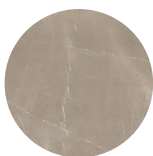

Tafu



Ceppo di Cré
Grey

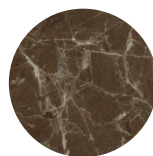

Emperador



Calacatta Black

FENIX



Bianco Malè
Malè White



Grigio Efeso
Efeso Grey

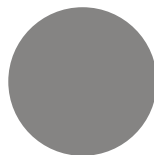

Grigio Londra
London Grey

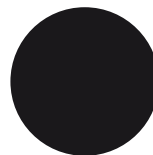

Nero
Black

VETRO | GLASS



Satinato Bianco
Satin White

FINITURE GAMBE | LEGS FINISHES

LACCATO | LACQUER



Zucca
NCS S2070-Y10R

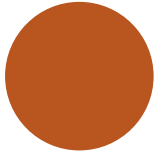

Mattone
NCS S3060-Y60R

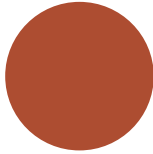

Pompei
NCS 4550-Y70R

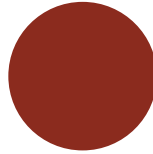

Bloody Mary
NCS 4550-Y80R

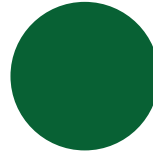

Pino
NCS S5040-G10Y

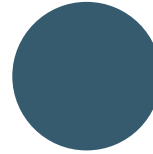

Bisanzio
NCS 6030-B

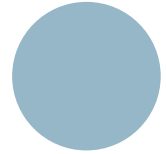

Nuvola
NCS S2020-B



Bianco
NCS S0502-Y



Burro
NCS S0510-G80Y



Creta
NCS S2005-Y10R

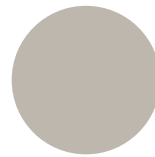

Grigio Seta
NCS S2502-Y

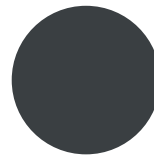

Antracite
NCS S7005-B20G

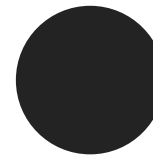

Nero
NCS S9000-N

LEGNO



Rovere Fiammato
Flamed Oak

ARTÙ PLUS

by Andrea Lucatello



Artù è un tavolo dalle forme sobrie e dalle linee minimali, funzionale nell'uso grazie ad un razionale sistema allungabile. Le gambe sono realizzate in legno massello, il piano in essenza impiallacciata su alluminio, in vetro extrachiario satinato retro laccato, in ceramica o in Fenix.

Artù is a table with sober shapes and minimal lines, functional thanks to a rational extendable system. The legs are made of solid wood, the top in veneer on aluminium, in lacquered satin extra-clear glass, in ceramic or in Fenix.

DIMENSIONI | DIMENSIONS



lunghezza | width: 150-190-230 cm
larghezza | depth: 101,3 cm
altezza | height: 77 cm

lunghezza | width: 180-220-260 cm
larghezza | depth: 101,3 cm
altezza | height: 77 cm

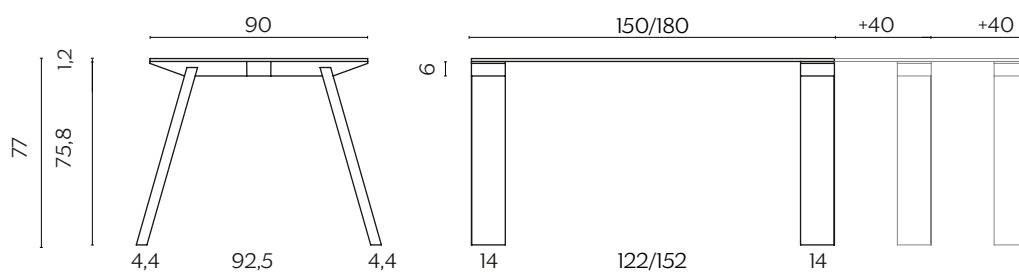

FINITURE PIANO | TOP FINISHES

LEGNO | WOOD



Rovere Fiammato
Flamed Oak



Rovere Vintage
Vintage Oak

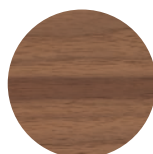

Noce Canaletto
Canaletto Walnut



Rovere Termotrattato
Heat-Treated Oak



Frassino Nero
Black Ash

GRES PORCELLANATO | PORCELAIN STONEWARE

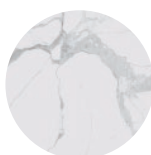

Statuario Bianco

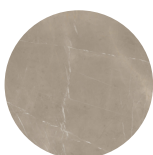

Tafu



Ceppo di Cré
Grey

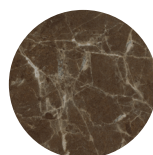

Emperador



Calacatta Black

FENIX



Bianco Malè
Malè White



Grigio Efeso
Efeso Grey

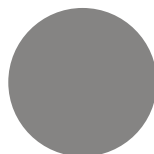

Grigio Londra
London Grey

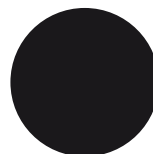

Nero
Black

VETRO | GLASS



Satinato Bianco
Satin White

FINITURE GAMBE | LEGS FINISHES

LACCATO | LACQUER

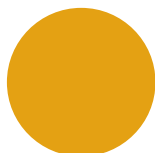

Zucca
NCS S2070-Y10R

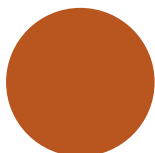

Mattone
NCS S3060-Y60R

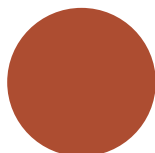

Pompei
NCS 4550-Y70R

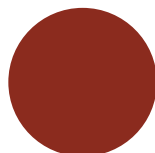

Bloody Mary
NCS 4550-Y80R

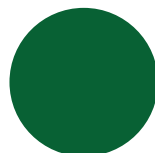

Pino
NCS S5040-G10Y

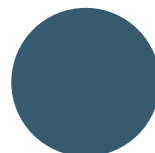

Bisanzio
NCS 6030-B

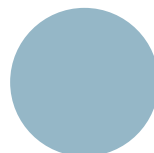

Nuvola
NCS S2020-B



Bianco
NCS S0502-Y



Burro
NCS S0510-G80Y



Creta
NCS S2005-Y10R



Grigio Seta
NCS S2502-Y

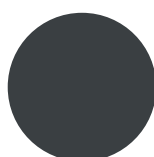

Antracite
NCS S7005-B20G

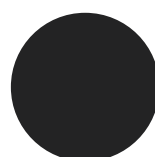

Nero
NCS S9000-N

LEGNO



Rovere Fiammato
Flamed Oak